

Article number: 0106041

Description: Retaining ring JV 24

Measures

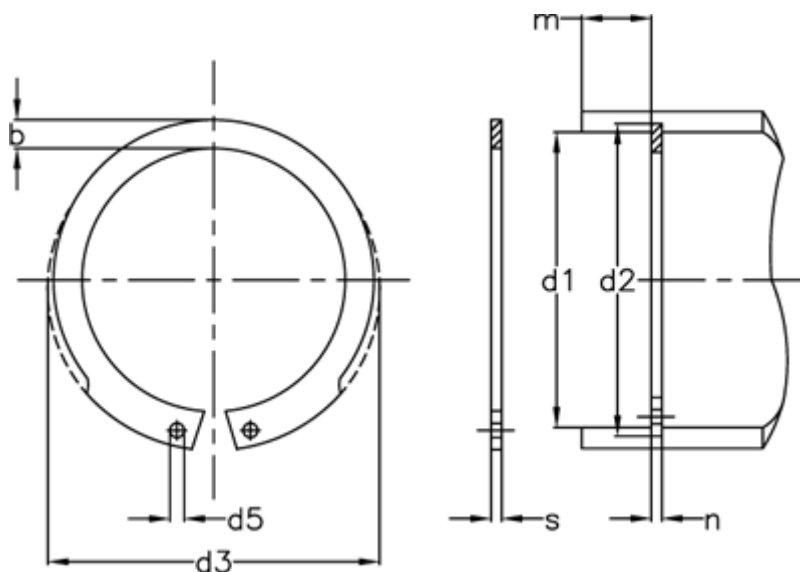

AN mm ²	= 22	FRg kN	= 4.8	tol	= 0.1
b	= 2.8	FR kN	= 14.5	tol	= -0.06
d1	= 24	g	= 1.0	tol	= +0,42-0,21
d2	= 25.2	K kN-mm	= 29.9	tol	= +0,21
d3	= 25.9	m min	= 1.30	Tong	= ZGJ-1
d5 min	= 1.5	Nominal drive	= 1.8	Weight kg/1000	= 1.30
Description	= JV 24	s	= 1.20		
FN kN	= 3.68	t	= 0.60		